

**NANTUCKET**™  
**BREEZE**

**AIR CONDITIONER**  
**REMOTE CONTROL MANUAL**

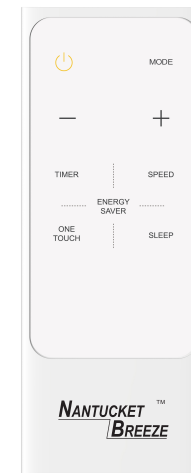

The design and specifications are subject to change without prior notice for product improvement. Consult with the sales agency or manufacturer for details.

CR188-RG15A(B)  
16117000000934

Thank you very much for purchasing our air conditioner.  
Please read this owner's manual carefully before using  
your air conditioner.

# CONTENTS

Using the remote control .....	2
Remote control specifications.....	3
Button functionality .....	4
How to use the buttons .....	5
Auto mode.....	5
Cooling/Fan mode.....	5
Dehumidifying mode .....	6
Sleep mode.....	6
Timer .....	7
Energy saving mode .....	9

## Using the remote control

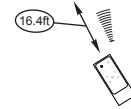
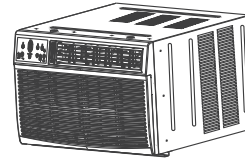

### Range of the remote control

- Use the remote control within 16.4 foot range from the appliance, pointing it towards the receiver. Reception is confirmed by a beep.

### CAUTIONS

- The air conditioner will not operate if curtains, doors or other materials block the signals from the remote control to the AC unit.
- Prevent any liquid from interfering into the remote control. Do not expose the remote control to direct sunlight or heat.
- If the infrared signal receiver on the AC unit is exposed to direct sunlight, the air conditioner may not function properly. Use curtains to prevent the sunlight from interfering on the receiver.
- If other electrical appliances react to the remote control, either move these appliances or consult your local dealer.

## Installation instructions of battery

**Step 1:** Insert a coin vertically in the groove on the battery cover, clockwise rotation of 45 degrees, make sure that the groove is aligned with the "unlock" sign as shown below and remove the battery cover.

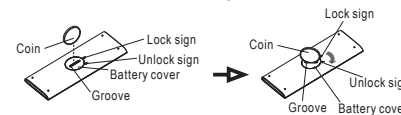

**Step 2:** Install battery inside the remote control, the positive (+) side up.

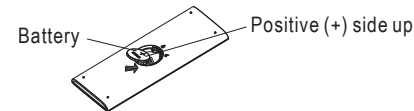

**Step 3:** Install the battery cover, make sure the battery cover groove is aligned with the "unlock" sign. Insert a coin vertically in the groove and press it gently, then counter clockwise rotation of 45 degrees, make sure the groove is aligned with the "lock" sign as shown below.



### WARNING

1. Battery must be disposed properly. Do not short circuit or dispose in the fire.
2. Keep batteries out of the reach of children.
3. Caution for ingestion.
4. Non-rechargeable batteries are not to be recharged.
5. Exhausted batteries are to be removed from the product.

## Remote Control Specifications

<b>Model</b>	RG15A(B)/E, RG15A1(B)/E, RG15A2(B)/E, RG15A3(B)/E,
<b>Rated Voltage</b>	3.0V( Dry batteries Lr03x2)
<b>Lowest Voltage of CPU Emitting Signal</b>	2.4V
<b>Signal Receiving Range</b>	16.4ft
<b>Environment</b>	-5°C~60°C(23°F~140°F)

### NOTE:

- Buttons design is based on typical model and might be slightly different from the actual one you purchased, the actual shape shall prevail.
- When there are wide differences between "Remote Control Illustration" and "USER'S MANUAL" on function description, the description on "USER'S MANUAL" shall prevail.

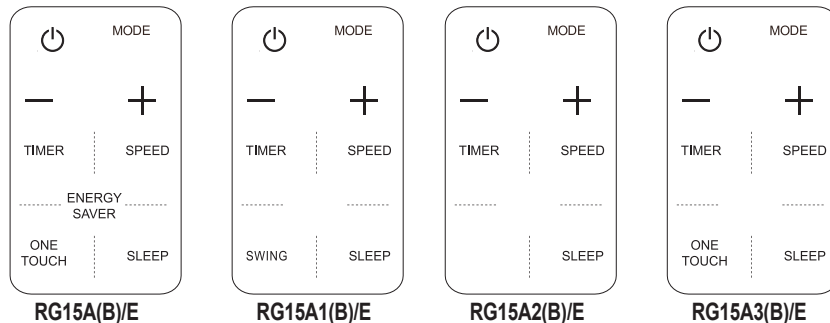

RG15A(B)/E

RG15A1(B)/E

RG15A2(B)/E

RG15A3(B)/E

## Button functionality

### ON/OFF button

Operation starts and stops when the button is pressed again.

NOTE: If the unit has ENERGY SAVER function, it will initiate automatically the Energy Saver function under Cool, Dry, and Auto (only Auto-Cooling and Auto-Fan) modes.

### TEMP DOWN button

Push this button to decrease the temperature setting in 1 °C/1 °F increments down to 17 °C/62 °F.

### TIMER button

Push this button to activate the "Auto Start" or "Auto Stop" program.

### ONE TOUCH button

Push this button, the system will automatically shift to COOL operation with auto fan speed, the setting temperature is 26°C/80°F. And the timer setting program will be cancelled. (on some models)

NOTE: On some models SWING replaces ONE TOUCH.

Push SWING button, the vertical louvers will swing automatically from side to side. Press it again to deactivate the "SWING" feature. (only on some models)

### MODE button

Press this button to select the desired operation mode from AUTO, COOL, DRY, and FAN.

### TEMP UP button

Push this button to increase the temperature setting in 1°C/1°F increments up to 30 °C/86 °F

### FAN button

Used to select the fan speed in four steps: Auto, Low, Med, and High.

### SLEEP button

Press this button to activate the Sleep mode. This function is available on COOL or AUTO mode to maintain a comfortable temperature.

### ENERGY SAVER button

Press this button to activate the Energy-saving mode. Press it again to stop the function. (only on some models)

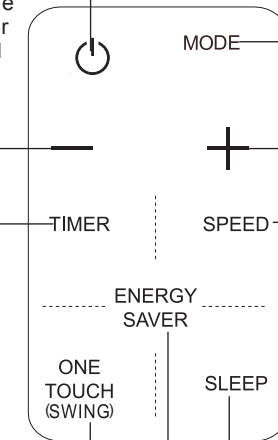

## How to use the buttons

### Auto mode

Ensure the unit is plugged in and power is available.

1. Press the **ON/OFF** button to start the air conditioner.
2. Press the **MODE** button to select Auto.
3. Press the **TEMP UP/DOWN** button to set the desired temperature. The temperature can be set within a range of 17°C/62°F~ 30°C/86°F in 1°C/1°F increments.

#### NOTE

1. In Auto mode, the air conditioner will automatically select the Cooling or Fan mode depending on the difference between the actual room temperature and the desired set temperature on the remote control.
2. In Auto mode, the fan speed is controlled automatically.
3. If the Auto mode is not comfortable for you, the desired mode can be selected manually.

### Cooling/Fan mode

Ensure the unit is plugged in and power is available.

1. Press the **ON/OFF** button to start the air conditioner.
2. Press the **MODE** button to select Cool, or Fan mode.
3. Press the **TEMP UP/DOWN** button to set the desired temperature. The temperature can be set within a range of 17°C/62°F~ 30°C/86°F in 1°C/1°F increments.
4. Press the **FAN** button to select the fan speed in four steps- Auto, Low, Med, or High.

#### NOTE

In the Fan mode, the setting temperature is not displayed in the remote control and you are not able to control the room temperature either. In this case, only step 1, 2 and 4 may be performed.

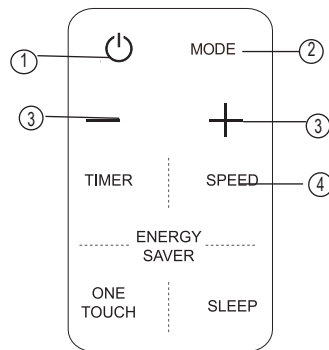
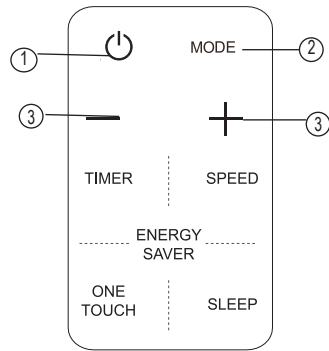

### Dehumidifying mode(only on some models)

Ensure the unit is plugged in and power is available.

1. Press the **ON/OFF** button to start the air conditioner.
2. Press the **MODE** button to select Dry.
3. Press the **TEMP UP/DOWN** button to set the desired temperature. The temperature can be set within a range of 17°C/62°F~ 30°C/86°F in 1°C/1°F increments.

#### NOTE

In the Dehumidifying mode, you cannot switch the fan speed. It is automatically controlled in this mode.

### Sleep mode

- Press this button to activate the Sleep mode. This function is available on COOL or AUTO mode only and maintain the most comfortable temperature for you.
- In this mode the selected temperature will increase by 1°C/2°F 30 minutes after the mode is selected. The temperature will then increase by another 1°C/2°F after an additional 30 minutes. This new temperature will be maintained for 6 hours before it returns to the originally selected temperature. This ends the Sleep mode and the unit will continue to operate as originally programmed.
- The Sleep mode program can be cancelled when press the MODE, ON/OFF, FAN SPEED and SLEEP button during operation.

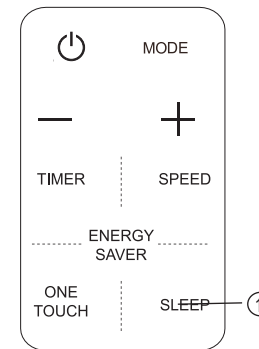
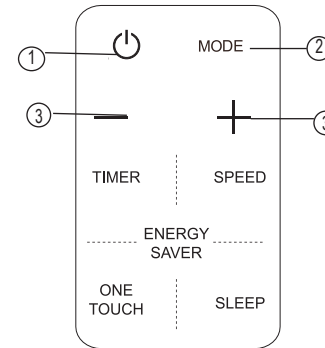

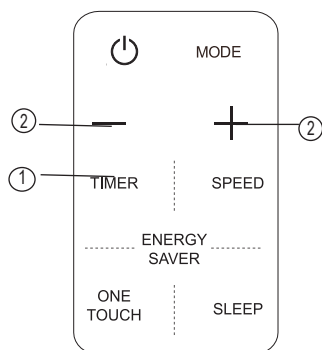

## **Timer**

Press the TIMER button can initiate the Auto-start and Auto-stop setting program of the unit. The time can be set in range of 0~24 hours.

### **To set the Auto-start/stop time.**

1. Press the TIMER button, when the TIMER ON indicator displayed on the LED window of the air conditioner, it indicates the Auto Start setting program is initiated. When the TIMER OFF indicator displayed on the LED window of the air conditioner, it indicates the Auto Stop setting program is initiated.
2. Press or hold the UP( + ) or DOWN( - ) to change the Auto time by 0.5 hour increments, up to 10 hours, then at 1 hour increments up to 24 hours. The control will count down the time remaining until start/stop.
3. The selected time will register in 5 seconds and the air conditioner will automatically revert back to the previous temperature setting.
4. Turning the unit ON or OFF at any time will cancel the Auto Start/Stop function.

**NOTE:** To cancel the TIMER setting, push the TIMER button and press or hold the UP( + ) or DOWN( - ) until 0 hour is displayed on the LED window of the air conditioner.

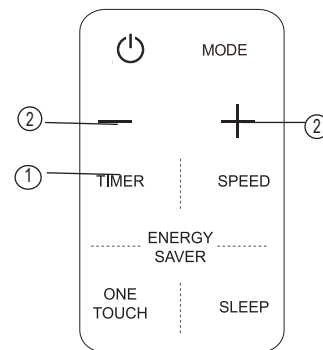

## **COMBINED TIMER**

(Setting both ON and OFF timers simultaneously)

### **AUTO STOP → AUTO START (On → Stop → Start operation)**

This feature is useful when you want to program the AC to automatically STOP and then START.

#### **Example:**

To stop the air conditioner 2 hours after setting and start it again 10 hours after setting.

1. Press the TIMER button until the TIMER OFF indicator is displayed on the LED display of the air conditioner.
2. Use the UP/DOWN button to display "2.0" on the LED display of the air conditioner.
3. Press the TIMER button again to display the TIMER OFF on the LED display of the unit.
4. Use the UP/DOWN button to display "10" on the LED display of the unit.
5. Wait for 5 seconds until the previous display revert back to the LED window.

### **AUTO START → AUTO STOP (Off → Start → Stop operation)**

This feature is useful when you want to program the AC to automatically START and then STOP.

#### **Example:**

To start the air conditioner 5 hours after setting, and stop it 8 hours after setting.

1. Press the TIMER button until the TIMER ON indicator is displayed on the LED display of the air conditioner.
2. Use the UP/DOWN button to display "5.0" on the LED display of the air conditioner.
3. Press the TIMER button again to display the TIMER OFF on the LED display of the unit.
4. Use the UP/DOWN button to display "8.0" on the LED display of the unit.
5. Wait for 5 seconds until the previous display revert back to the LED window.

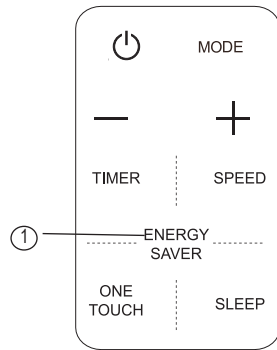

### **Energy saving mode**

In this mode, the fan will continue to run for 3 minutes after the compressor shuts off. The fan then cycles on for 2 minutes at 10 minute intervals until the room temperature is above the set temperature, at which time the compressor turns back on and cooling starts.

### **NOTE:**

- The device could comply with the local national regulations. In Canada, it should comply with CAN ICES-3(B)/NMB-3(B). In USA, this device complies with part 15 of the FCC Rules. Operation is subject to the following two conditions: (1) This device may not cause harmful interference, and (2) this device must accept any interference received, including interference that may cause undesired operation.
- This equipment has been tested and found to comply with the limits for a Class B digital device, pursuant to part 15 of the FCC Rules. These limits are designed to provide reasonable protection against harmful interference in a residential installation. This equipment generates, uses and can radiate radio frequency energy and, if not installed and used in accordance with the instructions, may cause harmful interference to radio communications. However, there is no guarantee that interference will not occur in a particular installation. If this equipment does cause harmful interference to radio or television reception, which can be determined by turning the equipment off and on, the user is encouraged to try to correct the interference by one or more of the following measures:
  - Reorient or relocate the receiving antenna.
  - Increase the separation between the equipment and receiver.
  - Connect the equipment into an outlet on a circuit different from that to which the receiver is connected.
  - Consult the dealer or an experienced radio/TV technician for help.
  - Changes or modifications not approved by the party responsible for compliance could void user's authority to operate the equipment.